

➔ **Global Hot Runner
Solution**

Vol. 1



A4 **HOTLINE IMPERIAL**

→ A4 Hotline Imperial

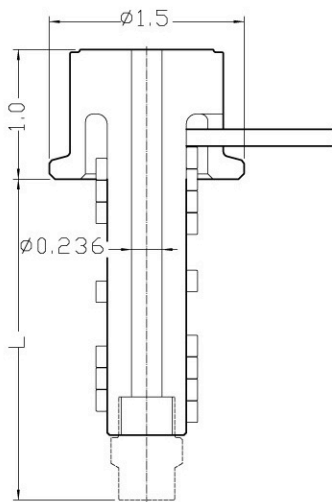

236 Series Nozzle

(0.236 diameter flow channel)

Body sub-assembly		Includes	
L	Item number	Nozzle body	Coil heater
2	A4BDA102023	A4BD102023	CS15150460250
2.5	A4BDA102523	A4BD102523	CS15150590300
3	A4BDA103023	A4BD103023	CS15150710350
3.5	A4BDA103523	A4BD103523	CS15150860400
4	A4BDA104023	A4BD104023	CS15150970400
5	A4BDA105023	A4BD105023	CS15151220500
6	A4BDA106023	A4BD106023	CS15151500600

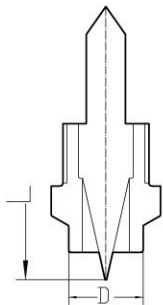
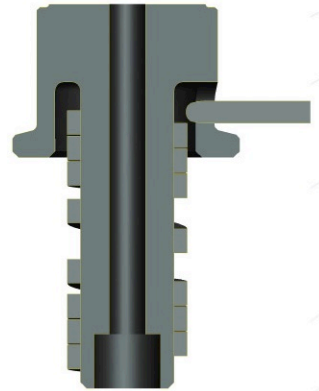

Point Gate Open

Item number	Needle	Nut	D
A4NOS10375	A4TN12713	A4OS103704	0.375

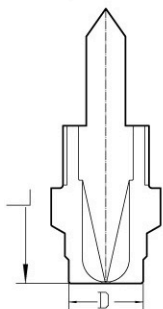
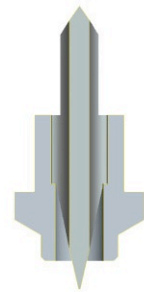

Point Gate Nut

Item number	Needle	Nut	D
A4NPS10375	A4TN12713	A4PS103704	0.375
A4NPS10500		A4PS105004	0.5

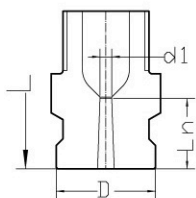
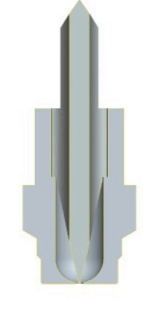

Sprue Gate/Extended Sprue Gate

Item number	Ln	d1	D
A4ENS10500	0.375	0.08	0.5
A4ENS10750			0.75
A4ENS11000			1
A4ENX10500	1.125	0.08	0.5
A4ENX10750			0.75
A4ENX11000			1



Shot Weight under Different Viscosity

Shot weight (g)	Low	Middle	Hight
A4NOS10375	<330	<220	<100
A4NPS10375	<330	<220	<100
A4ENS10500	<500	<270	<150

*Something missing? -We make it for you!

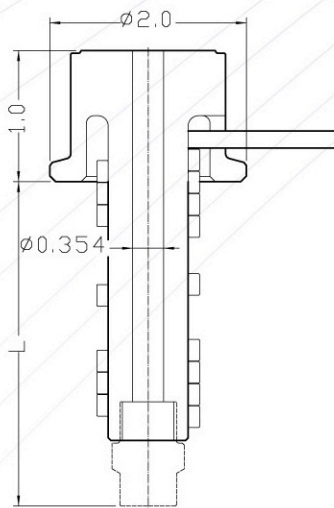

354 Series Nozzle

(0.354 diameter flow channel)

Body sub-assembly		Includes	
L	Item number	Nozzle body	Coil heater
2	A4BDA202035	A4BD202035	CS15210460350
2.5	A4BDA202535	A4BD202535	CS15210590400
3	A4BDA203035	A4BD203035	CS15210710450
3.5	A4BDA203535	A4BD203535	CS15210860500
4	A4BDA204035	A4BD204035	CS15210970550
5	A4BDA205035	A4BD205035	CS15211220650
6	A4BDA206035	A4BD206035	CS15211480650
7	A4BDA207035	A4BD207035	CS15211730750

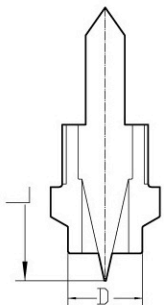
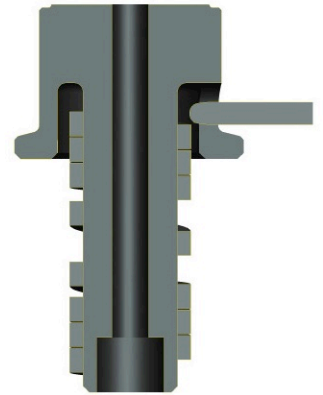

Point Gate Open

Item number	Needle	Nut	D
A4NOS20500	A4TN23914	A4OS205005	0.5

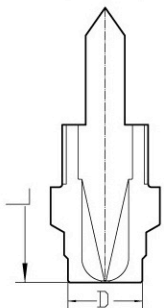

Point Gate Nut

Item number	Needle	Nut	D
A4NPS20500	A4TN23914	A4PS205005	0.5
A4NPS20750		A4PS207505	0.75
A4NPS21000		A4PS210005	1

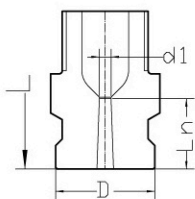
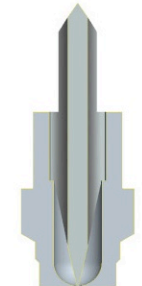

Sprue Gate/Extended Sprue Gate

Item number	Ln	d1	D
A4ENS20500	0.375	0.125	0.5
A4ENS20750			0.75
A4ENS21000			1
A4ENX20500	1.125	0.125	0.5
A4ENX20750			0.75
A4ENX21000			1

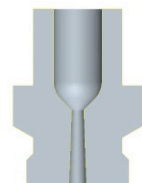

Shot Weight under Different Viscosity

Shot weight (g)	Low	Middle	Hight
A4NOS20500	<580	<340	<200
A4NPS20500	<580	<340	<200
A4ENS20500	<850	<400	<280

*Something missing? -We make it for you!

→A4 Hotline Imperial

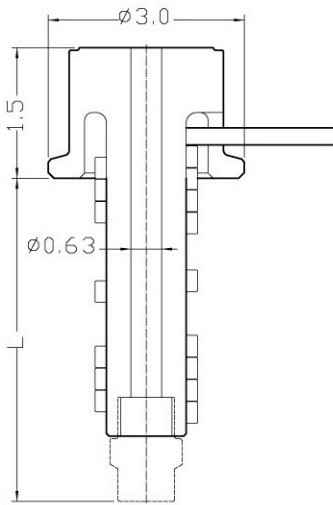

630 Series Nozzle

(0.63 diameter flow channel)

Body sub-assembly		Includes	
L	Item number	Nozzle body	Coil heater
4	A4BDA304063	A4BD304063	CS02360700750
5	A4BDA305063	A4BD305063	CS02360950850
6	A4BDA306063	A4BD306063	CS02361210900
7	A4BDA307063	A4BD307063	CS02361461050
8	A4BDA308063	A4BD308063	CS02361721200
9	A4BDA309063	A4BD309063	CS02361971350
10	A4BDA310063	A4BD310063	CS02362501600

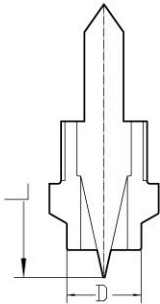
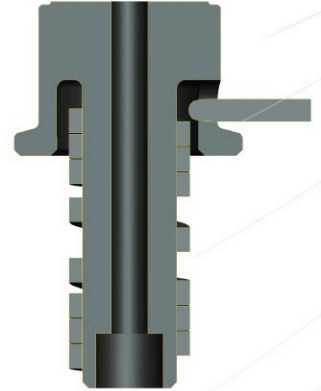

Point Gate Open

Item number	Needle	Nut	D
A4NOS30625	A4TN36623	A4OS306209	0.625

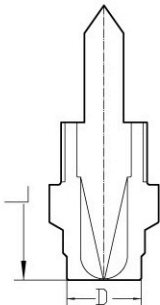

Point Gate Nut

Item number	Needle	Nut	D
A4NPS31000	A4TN36623	A4PS310009	1

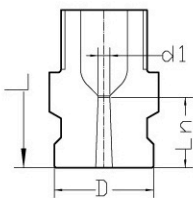

Sprue Gate/Extended Sprue Gate

Item number	Ln	d1	D
A4ENS31000	0.5	0.187	1
A4ENX31000	1.25	0.187	1

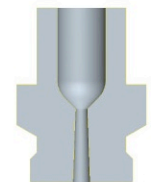
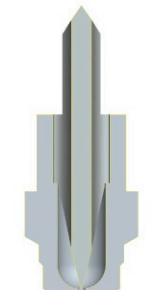
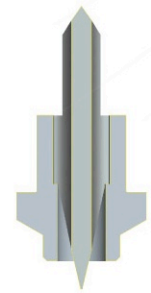

Shot weight under different viscosity

Shot weight (g)	Low	Middle	Hight
A4NOS30625	<1300	<700	<450
A4NPS31000	<1300	<700	<450
A4ENS31000	<1880	<900	<600

*Something missing? -We make it for you!